

BIN 16

Assembly and fitting instructions

innostor



IMPORTANT - The unit has a maximum loading limit of 25kg.

Parts



x16 M4 x 16mm screw



x6 M4 x 25mm screw

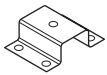

x4 Brackets

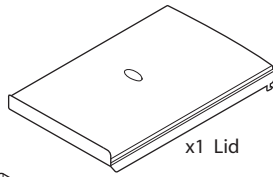

x1 Lid

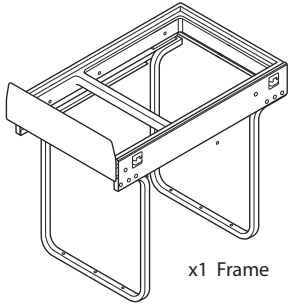

x1 Frame

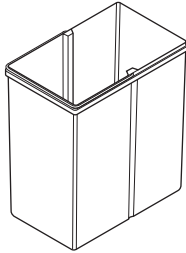

x1 Large Container

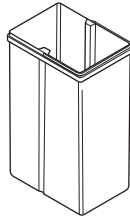

x1 Small Container

Dimensions - maximum

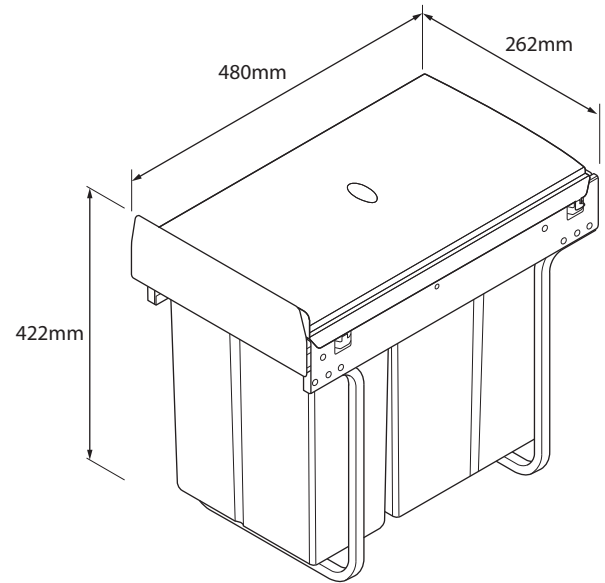

Please ensure that all the above fittings are present before installation begins.

- 1 Measure 88mm from the cabinet front face and position the frame allowing for any obstruction from above or the sides. Fit the two long screws through the central holes

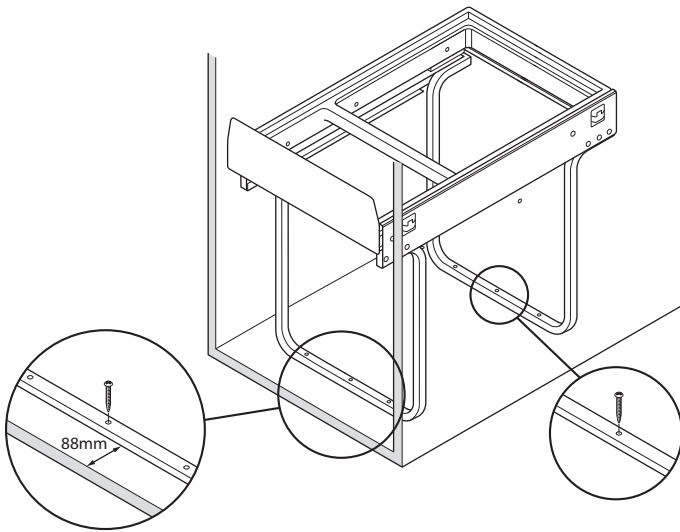

- 2 Before permanent attachment to the cabinet base, fit containers and lid and test for ease of opening and container removal. Ensure the unit is clear of door hinges and other obstructions during operation. Make adjustments if necessary.

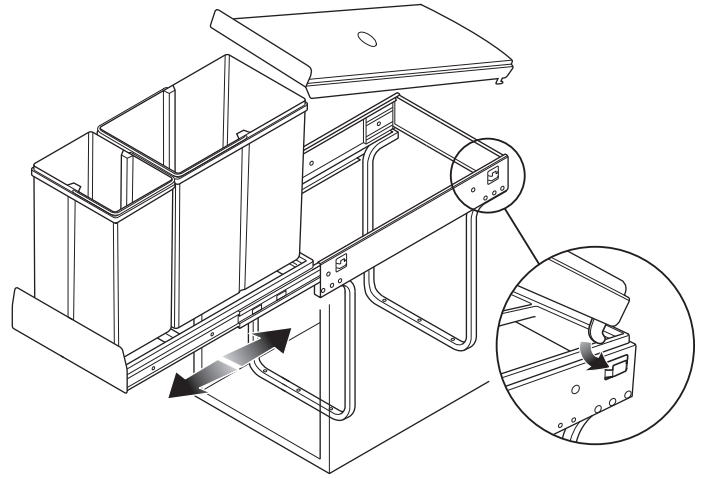

- 3 Attach the four brackets to the cabinet base using x4 short screws and x1 long screw to each bracket.

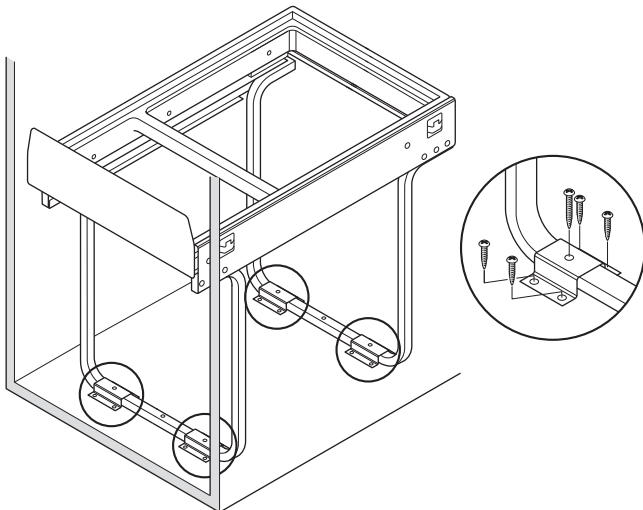

- 4 Fit the containers and lid

